



User: Guest18040517500112

Printed: 04/05/2018 13:13

All Products > Wire Feeder Welders > POWER MIG > POWER MIG 140C - 12632 > Parts Page > P-1060-A - INDEX OF SUB ASSEMBLIES





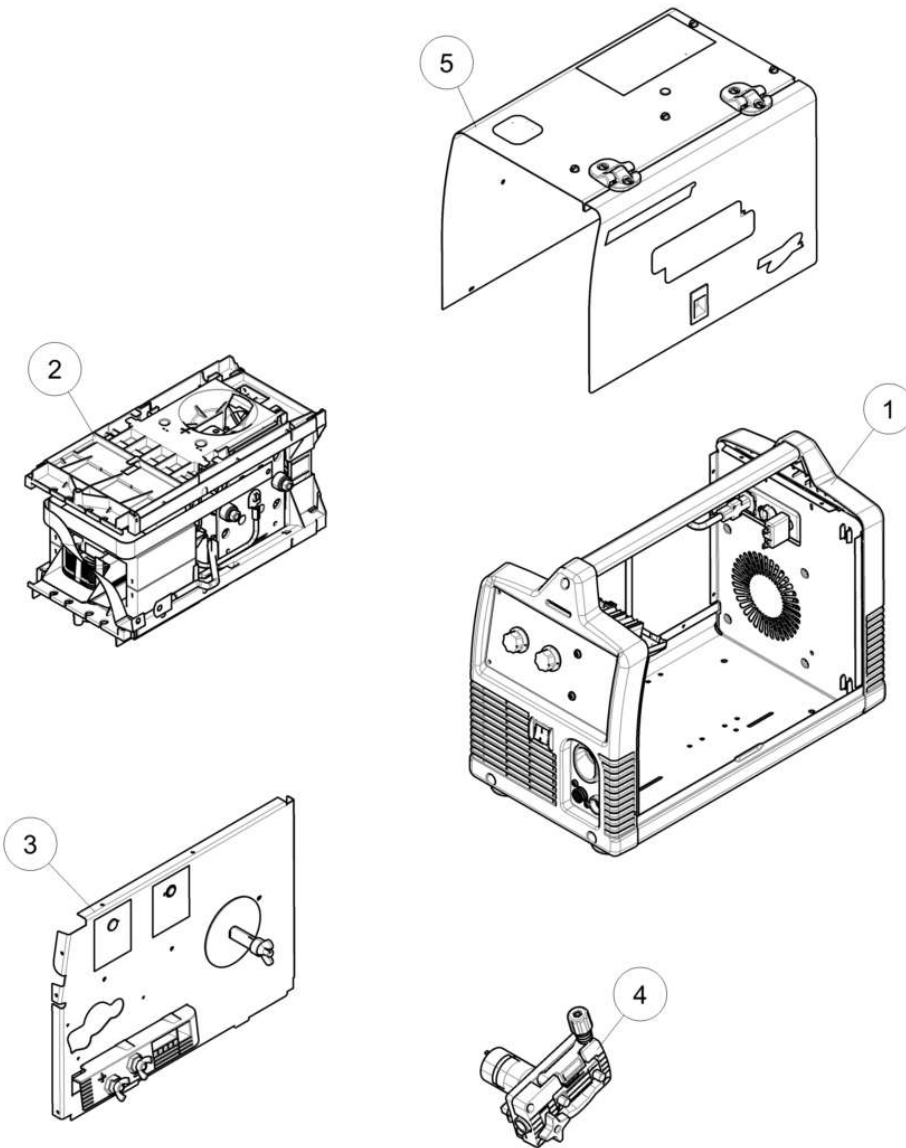

Name: P-1060-A - INDEX OF SUB ASSEMBLIES

Illustrations



P-1060-A

Parts List

		Part Number: P-1060-B MISCELLANEOUS ITEMS	Quantity: 1
1		Part Number: P-1060-C GENERAL ASSEMBLY	Quantity: 1
2		Part Number: P-1060-D POWER MODULE ASSEMBLY	Quantity: 1
3		Part Number: P-1060-E CENTER PANEL ASSEMBLY	Quantity: 1
4		Part Number: P-1060-F WIRE DRIVE ASSEMBLY	Quantity: 1
5		Part Number: P-1060-G WRAPAROUND ASSEMBLY	Quantity: 1